



SOBE
SINIFLANDIRMA
KARTLARI



Kullanım Talimatları

1-Bu materyal sınıflandırma becerilerini öğretmek amacıyla geliştirilmiştir. Bu setlerde örnek olarak farklı kategorilere ait resimlerinden oluşan görsellere yer verilmiştir.

2-Çocuğun ilgi duyduğu hayvanları, yiyecekleri, içecekleri nesnelere, hazırlayarak çalışmalarını geliştirebilirsiniz.

3-Resimli kartları dayanıklı hale getirebilmek için kartları laminasyon kaplama yapabilir şeffaf koli bandı ile kaplayabilir ya da şeffaf kartlıklar kullanabilirsiniz.

1-Öğrencinin önüne öğretmek istediğiniz kategorilerin birer görselini koyun.

2-Kategorilere ait resimlerden birini seçip öğrenciye " buzdolabını bul!" yönergesini yöneltin.

3-Sunduğunuz yönergenin ardından fiziksel ipucu ile öğrencinin sorulan resmin kategorisini bulmasını sağlayın.

4-"Buzdolabını buldun, aferin" diyerek doğru yaptığını ifade edin ve hoşuna giden bir pekiştirme sunun.

KIYAFETLER



Set 1 Kıyafetler

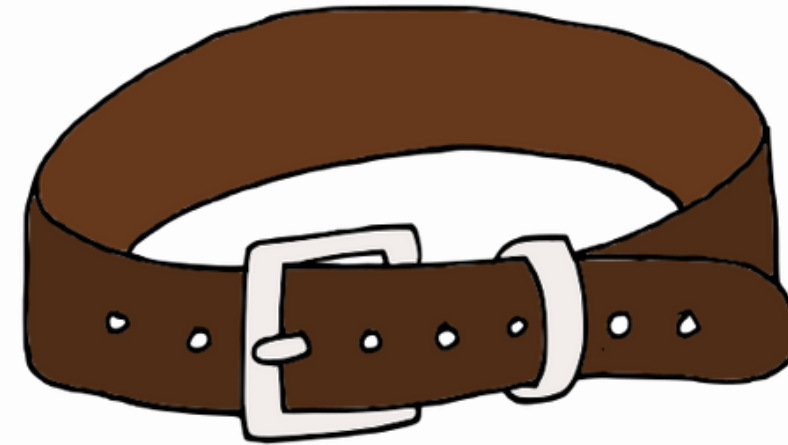
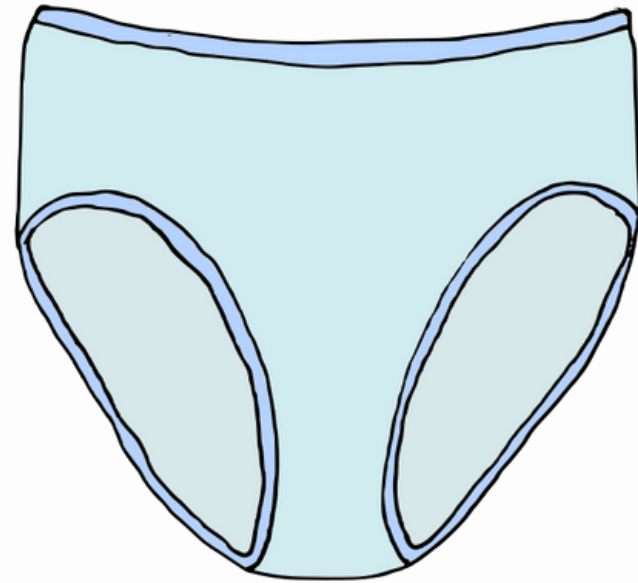
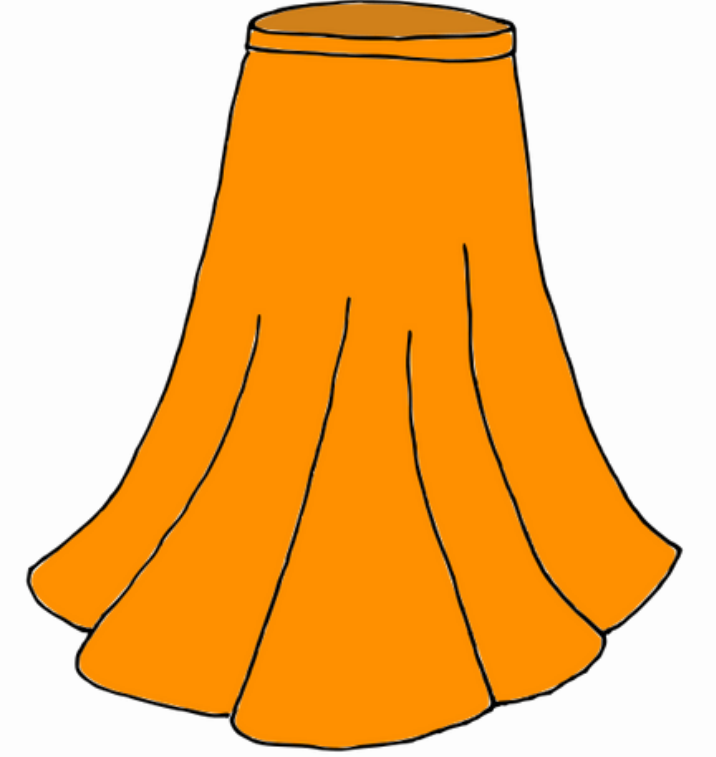
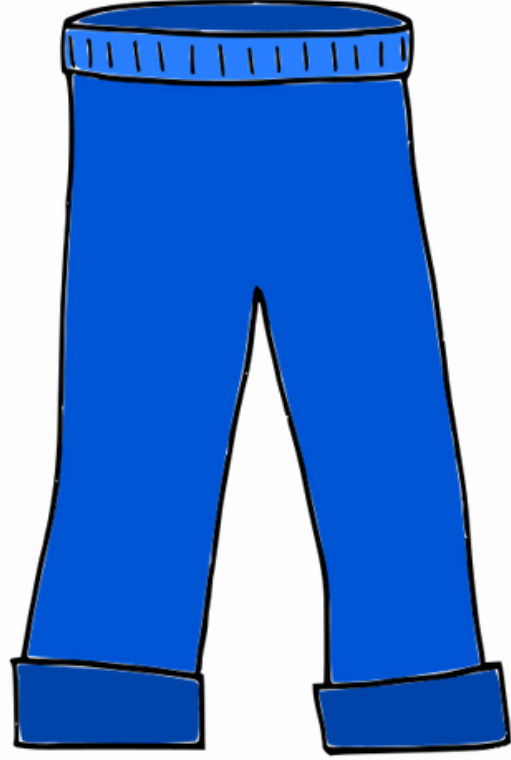

Set 1 Kıyafetler

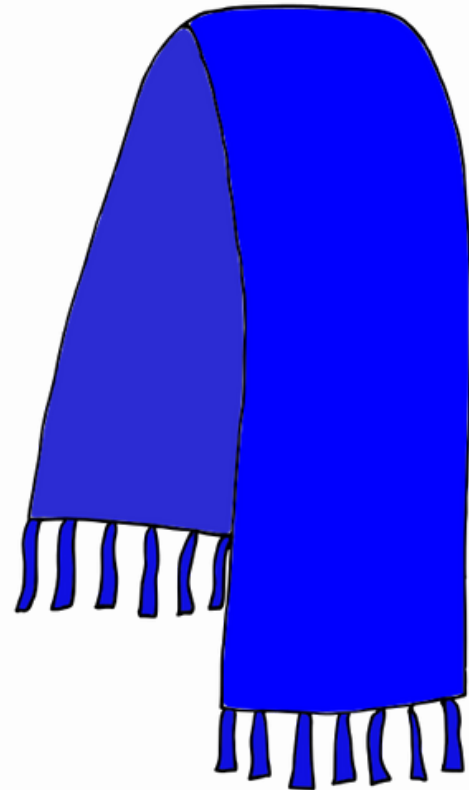
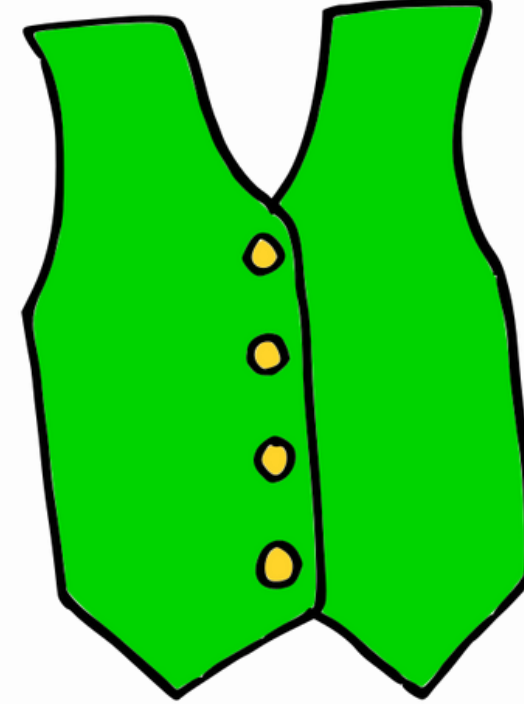
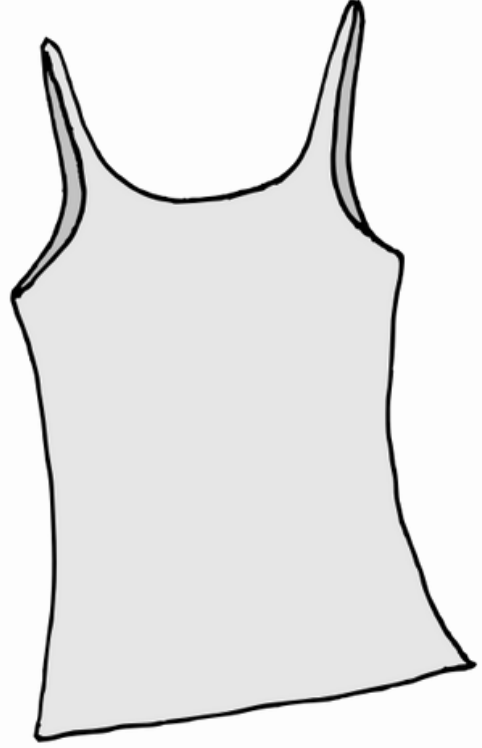

EŐYALAR

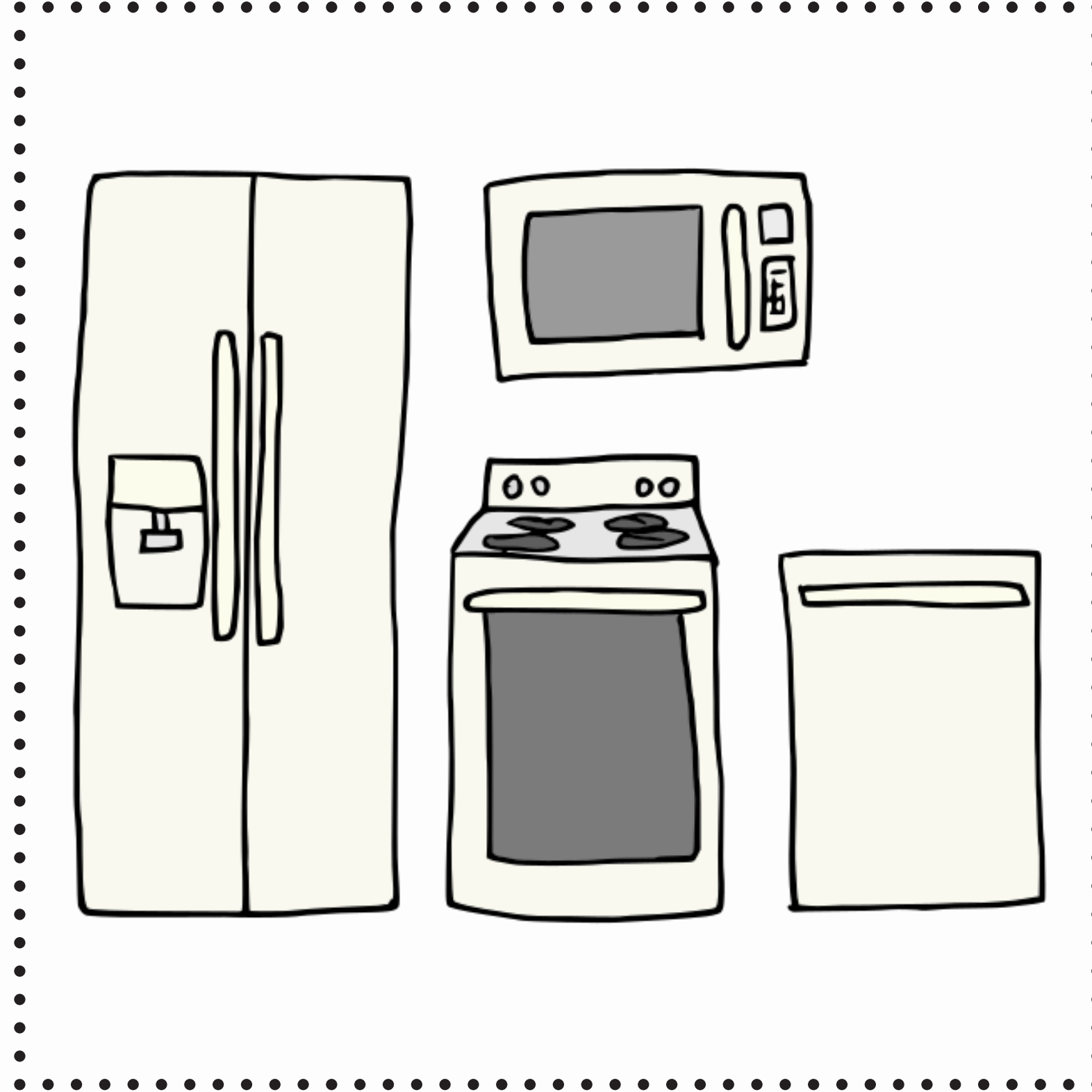

Set 2 Eşyalar

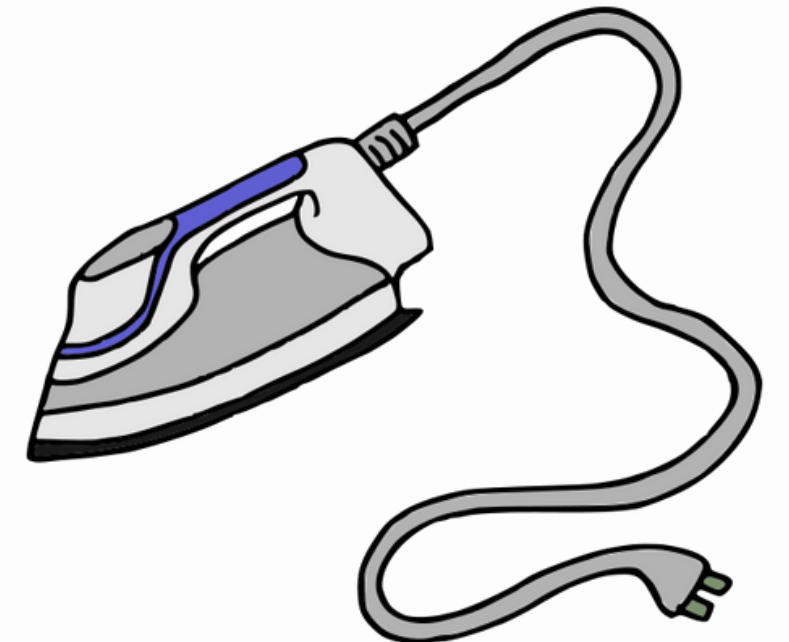
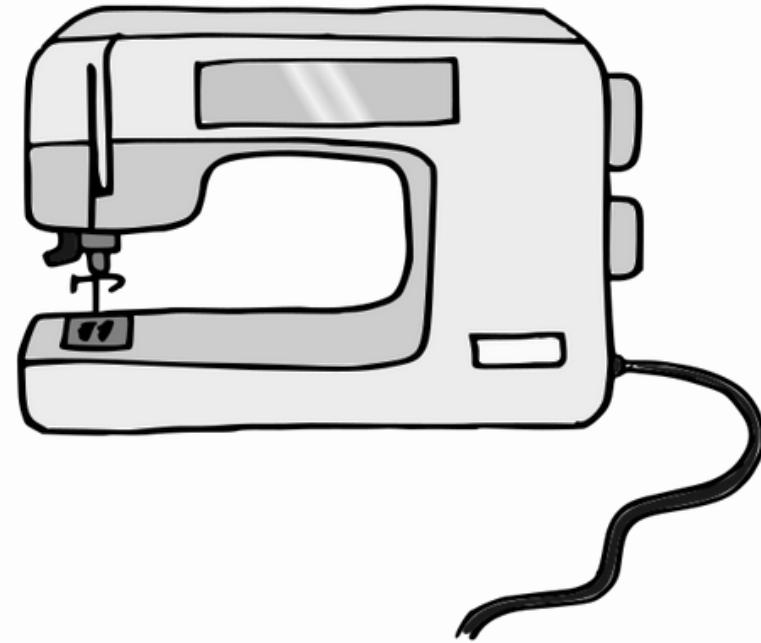
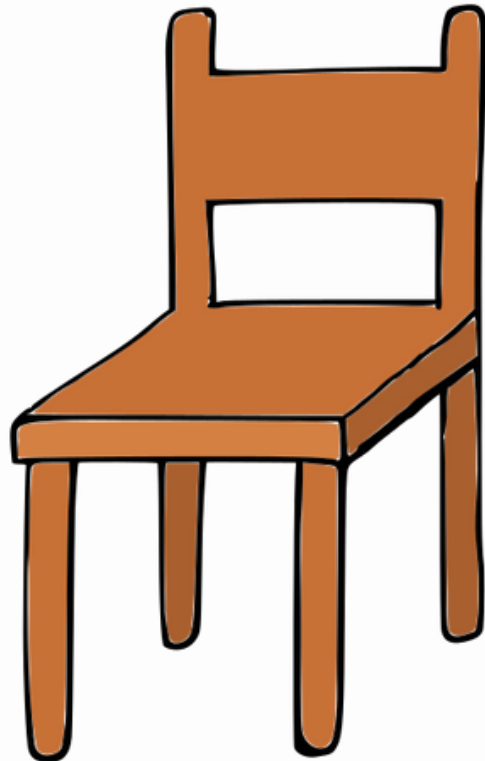
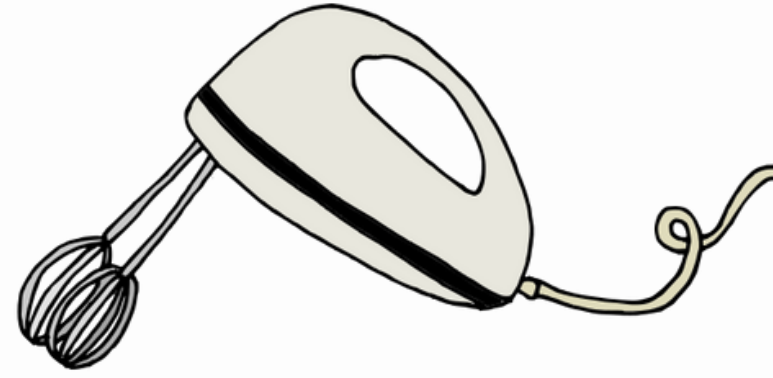
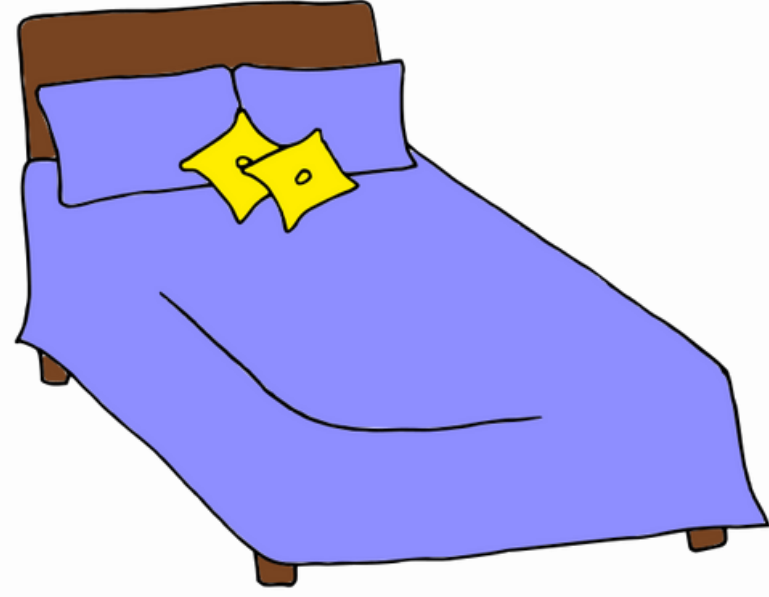
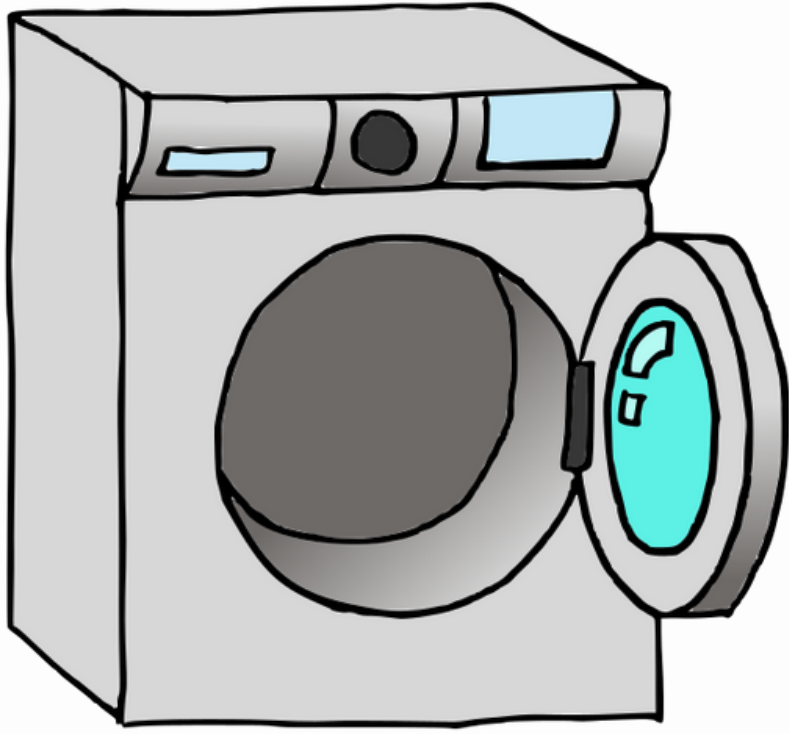

Set 2 Eşyalar

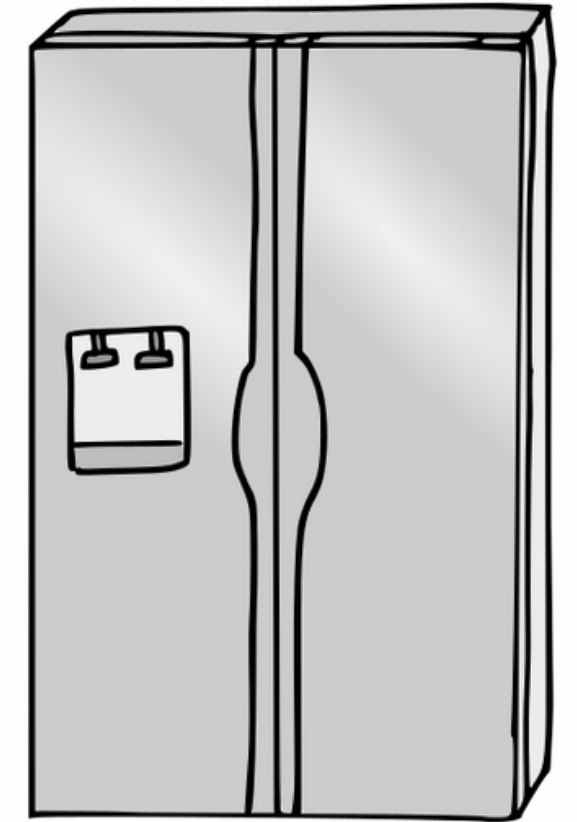
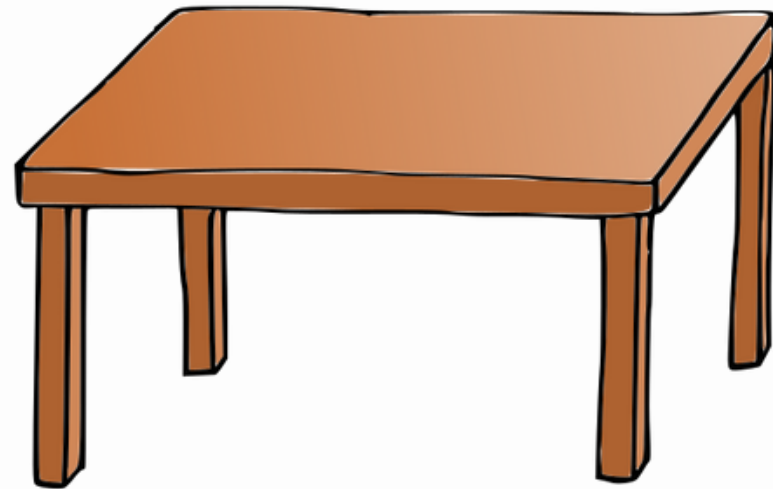
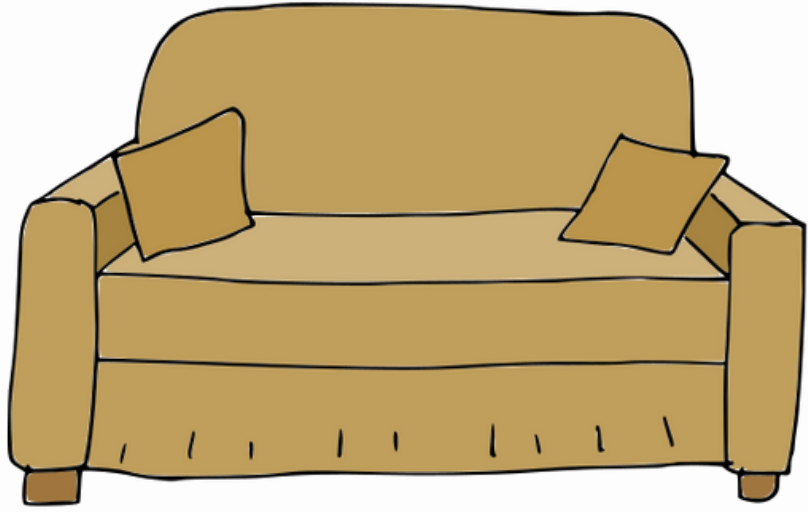

OYUNCAKLAR

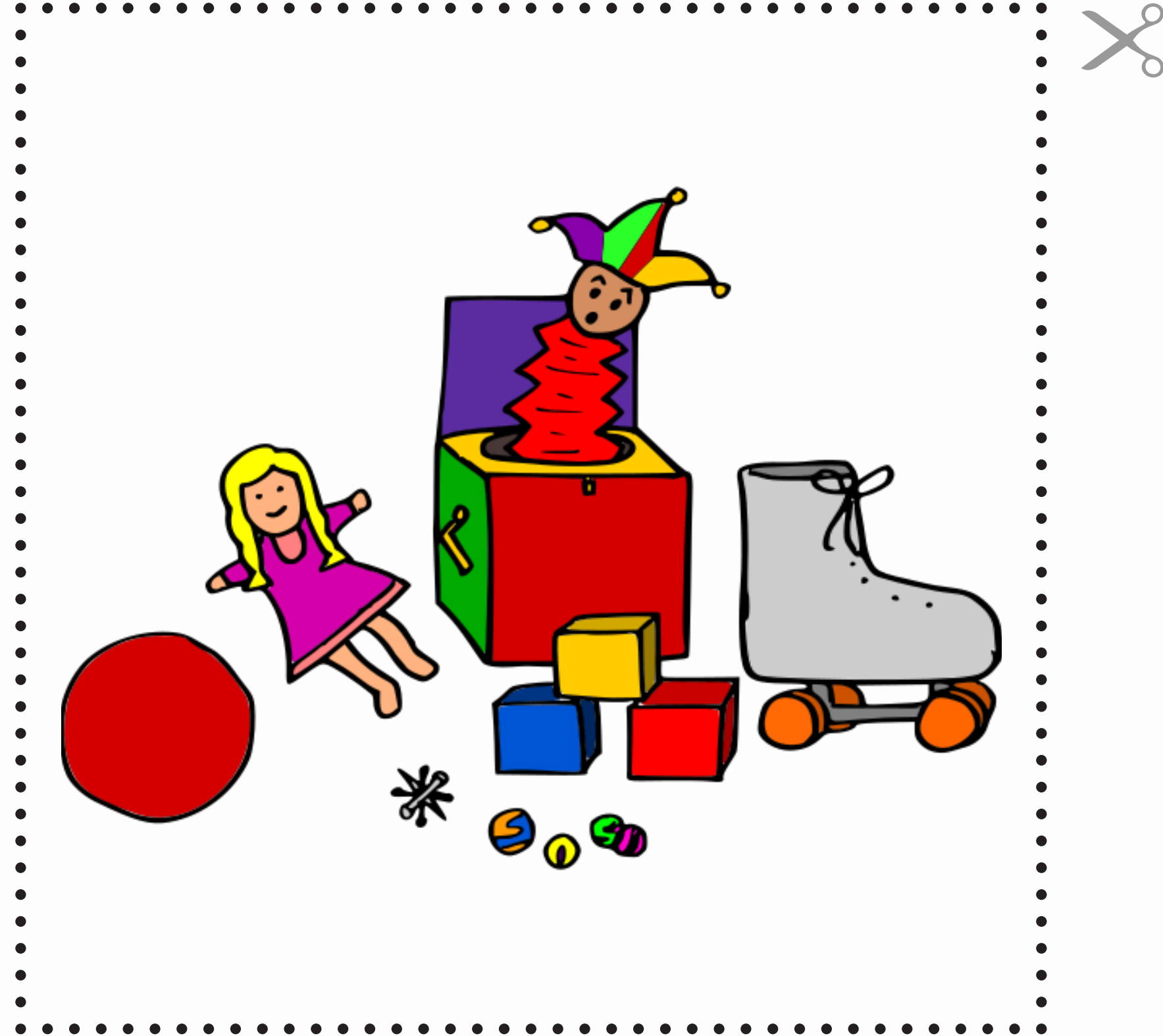

Set 3 Oyuncaklar

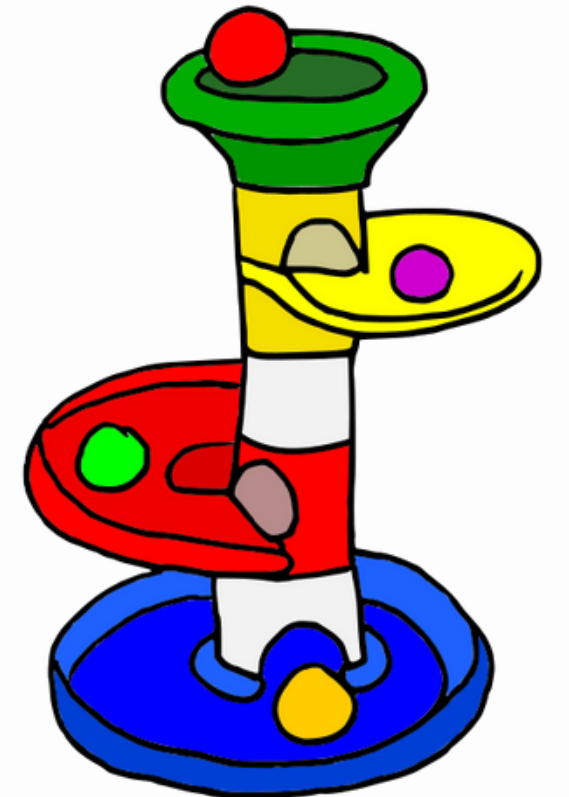
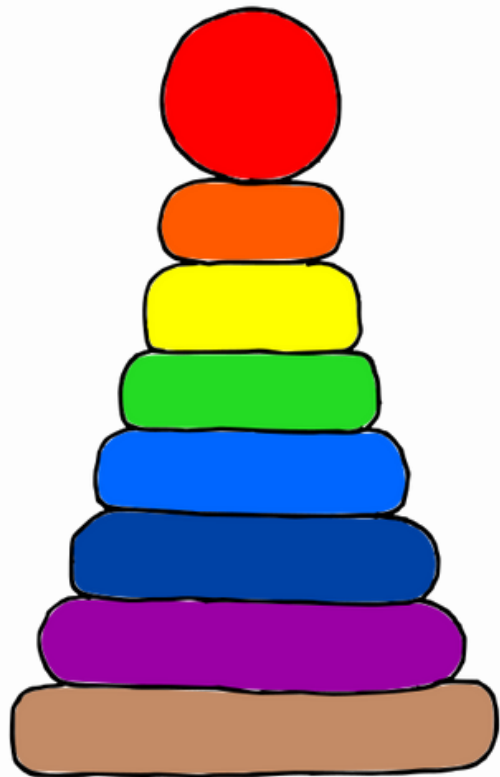
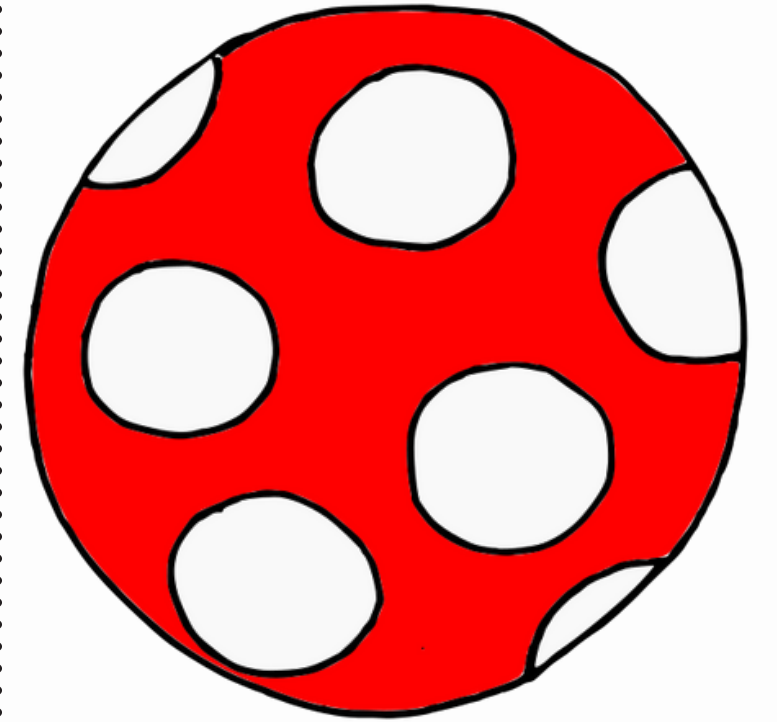
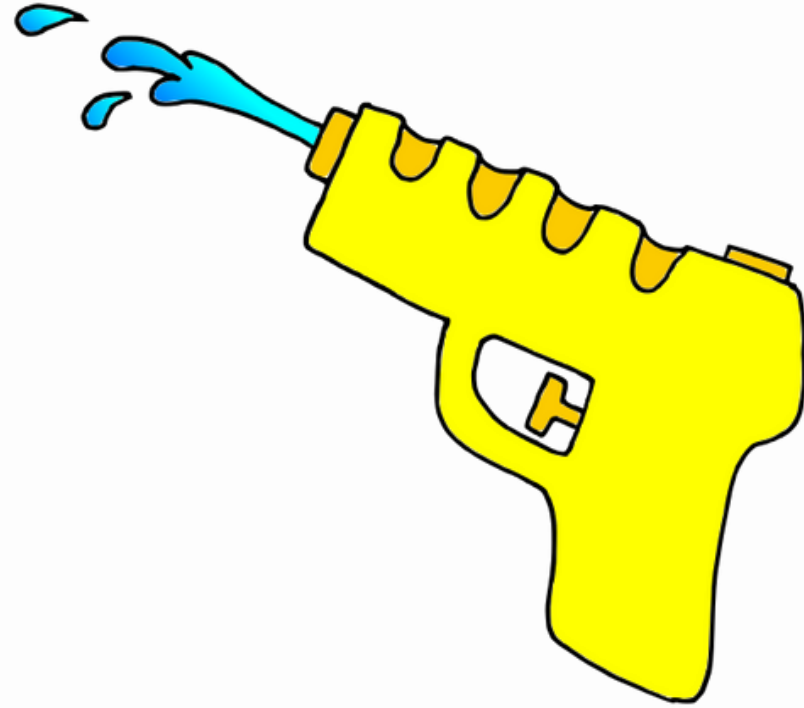
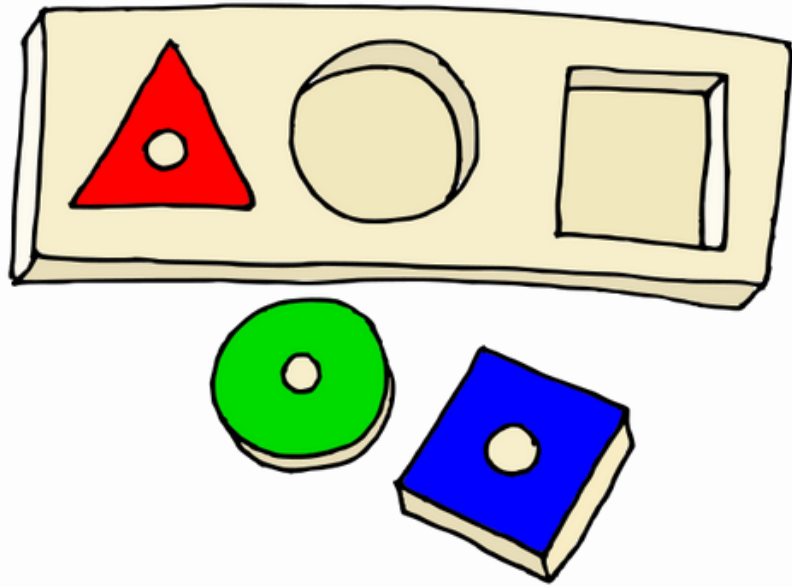

Set 3 Oyuncaklar

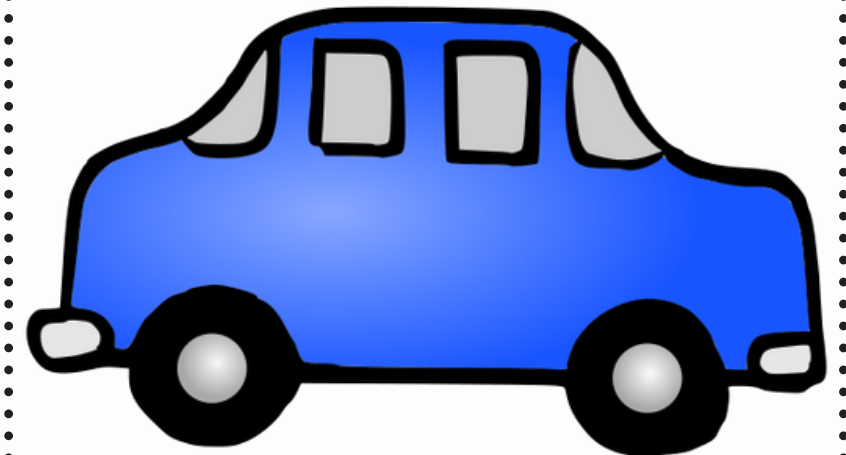
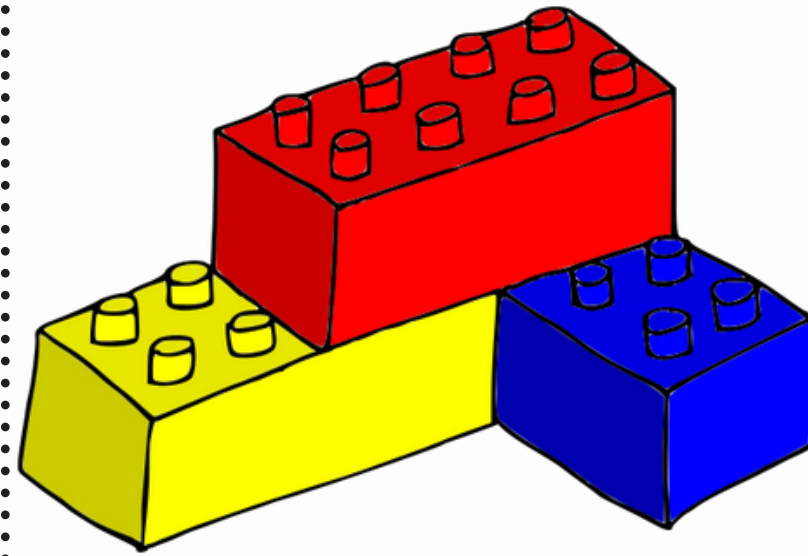
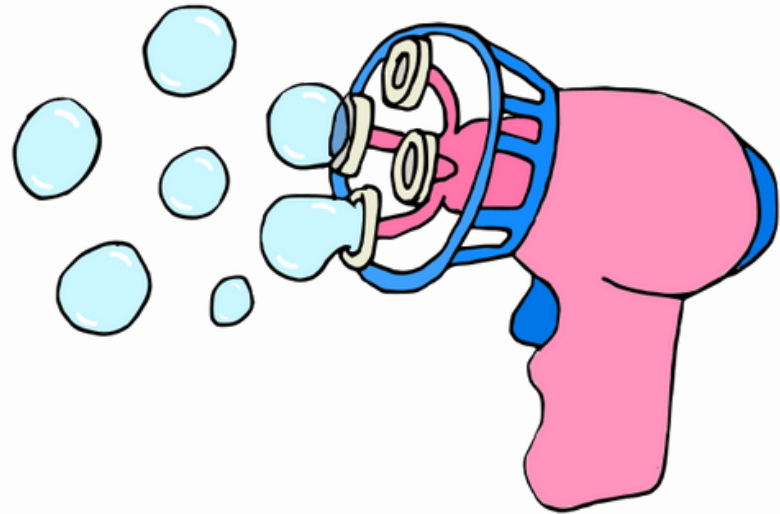
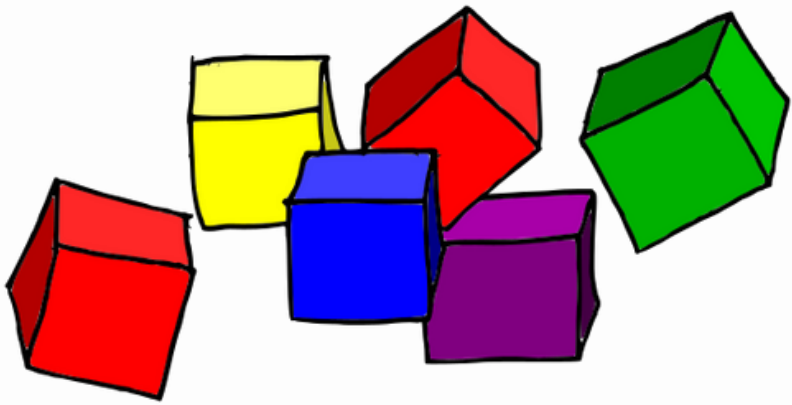
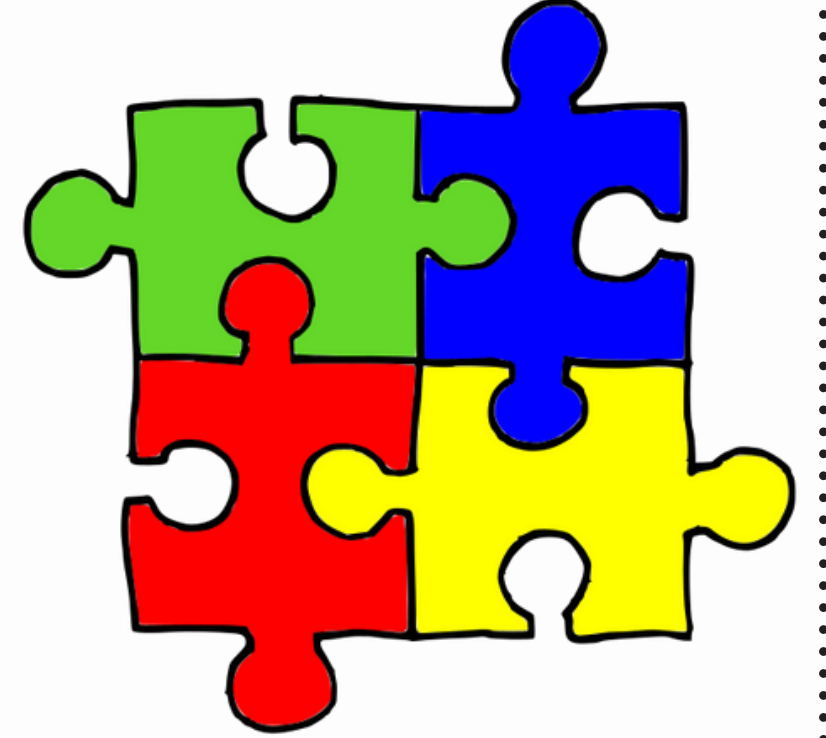
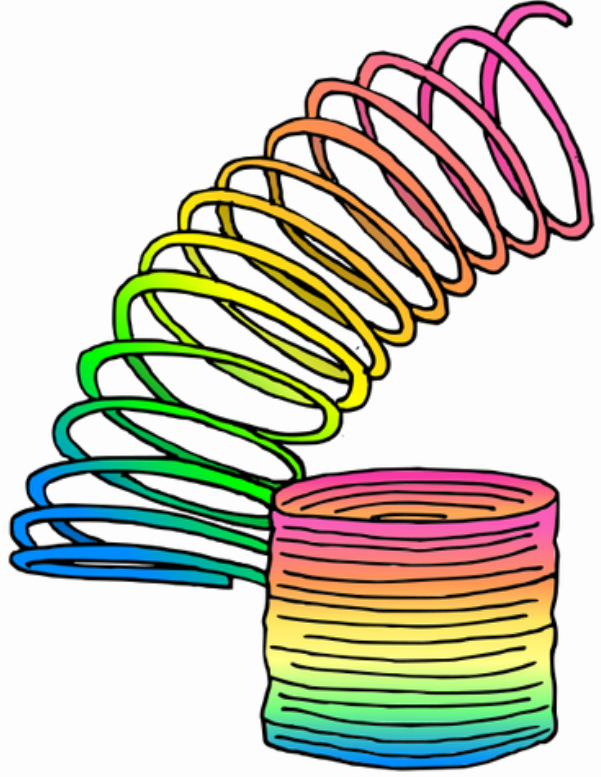

KIRTASIYE



Set 4 Kırtasiye

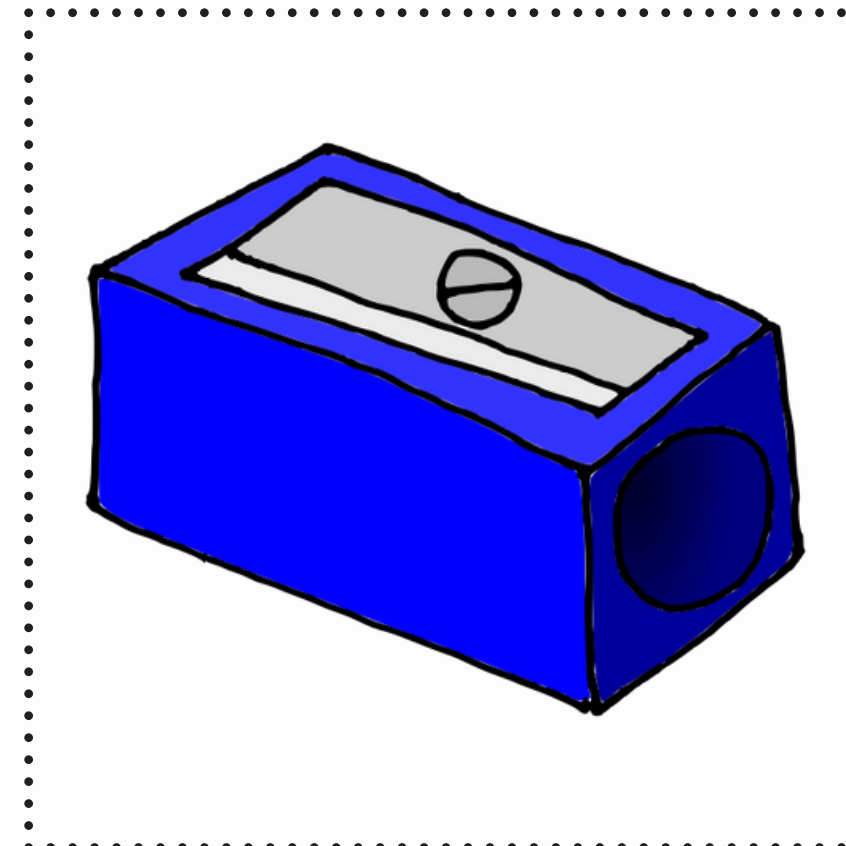
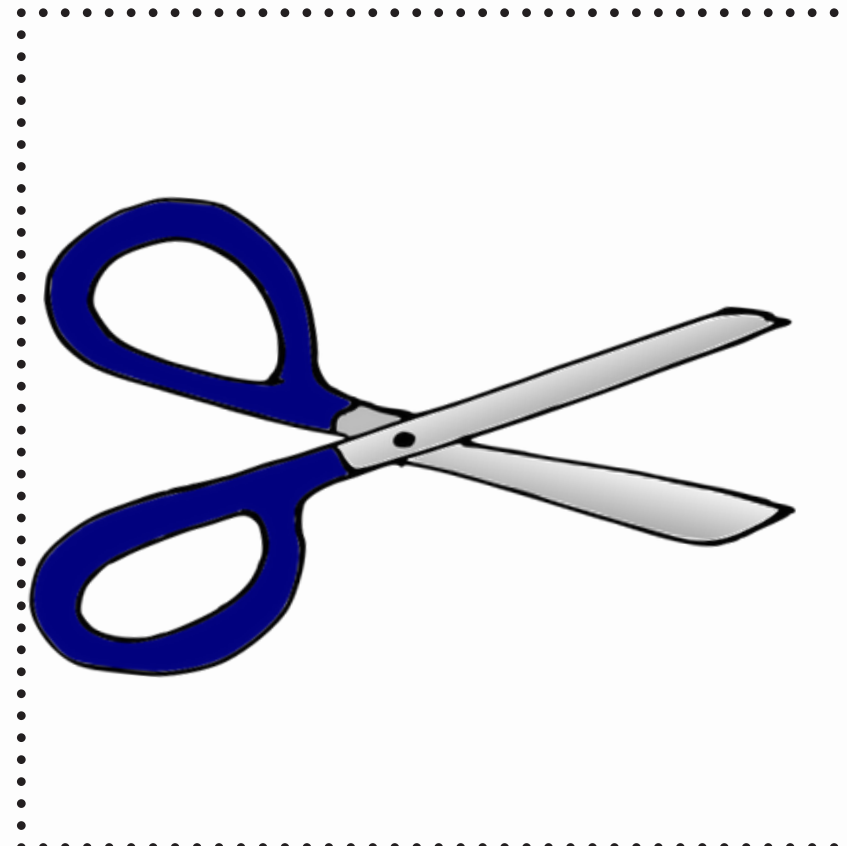
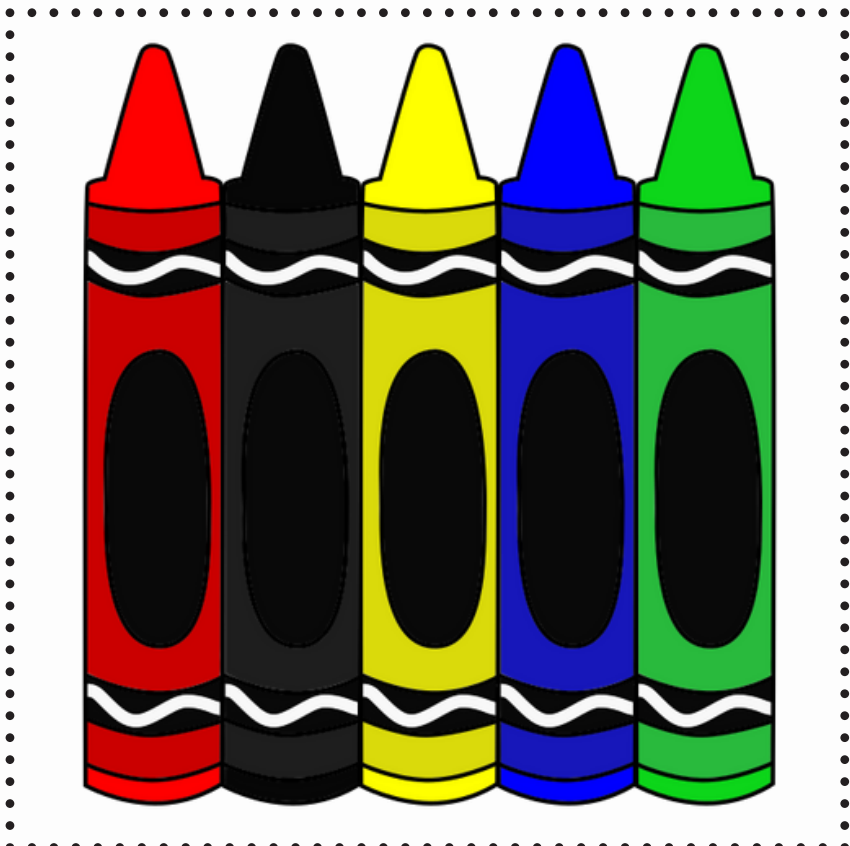
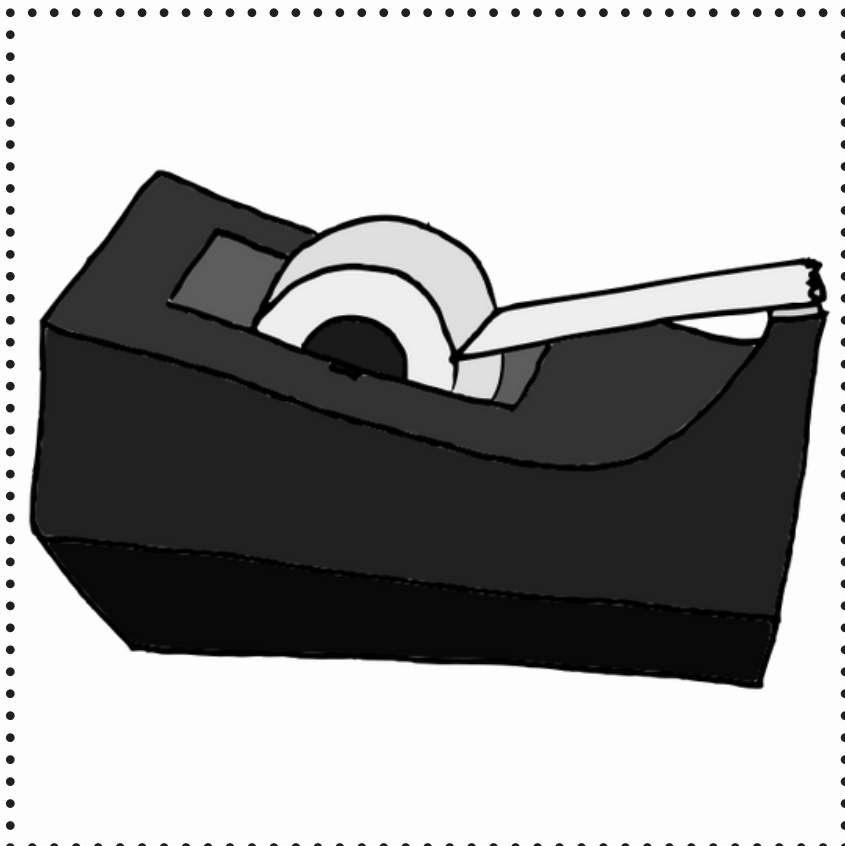
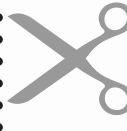
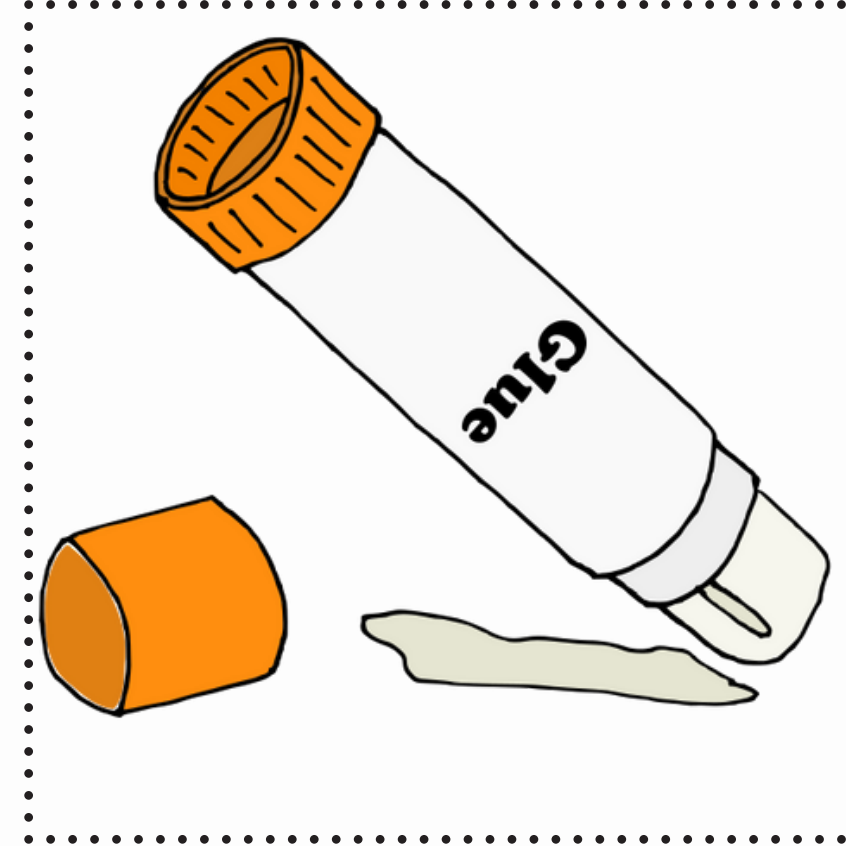
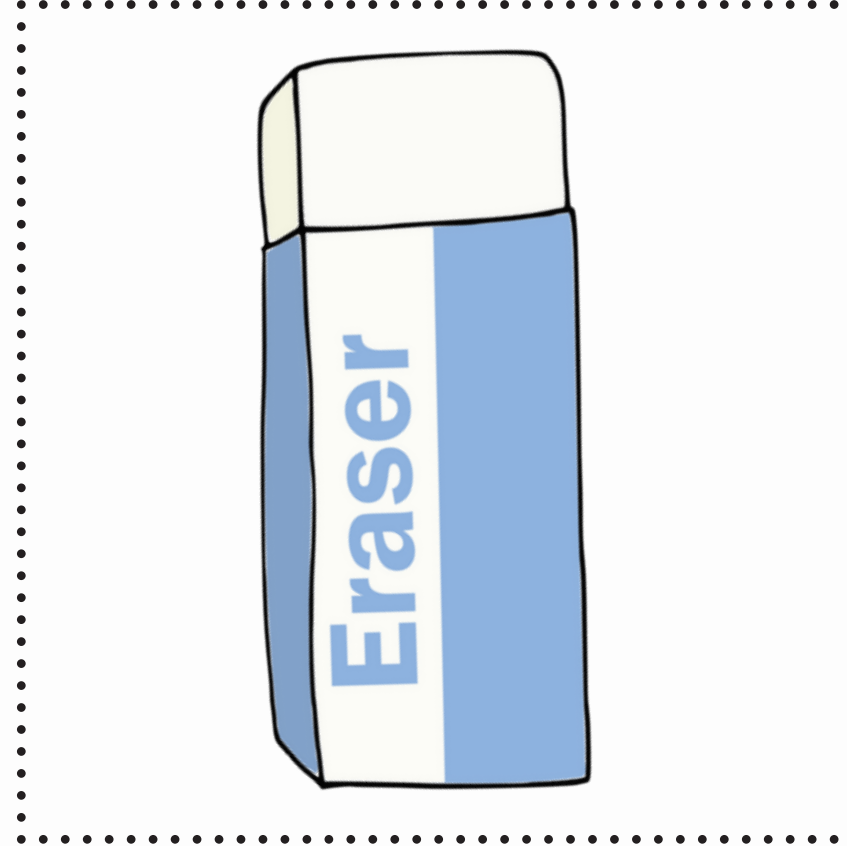
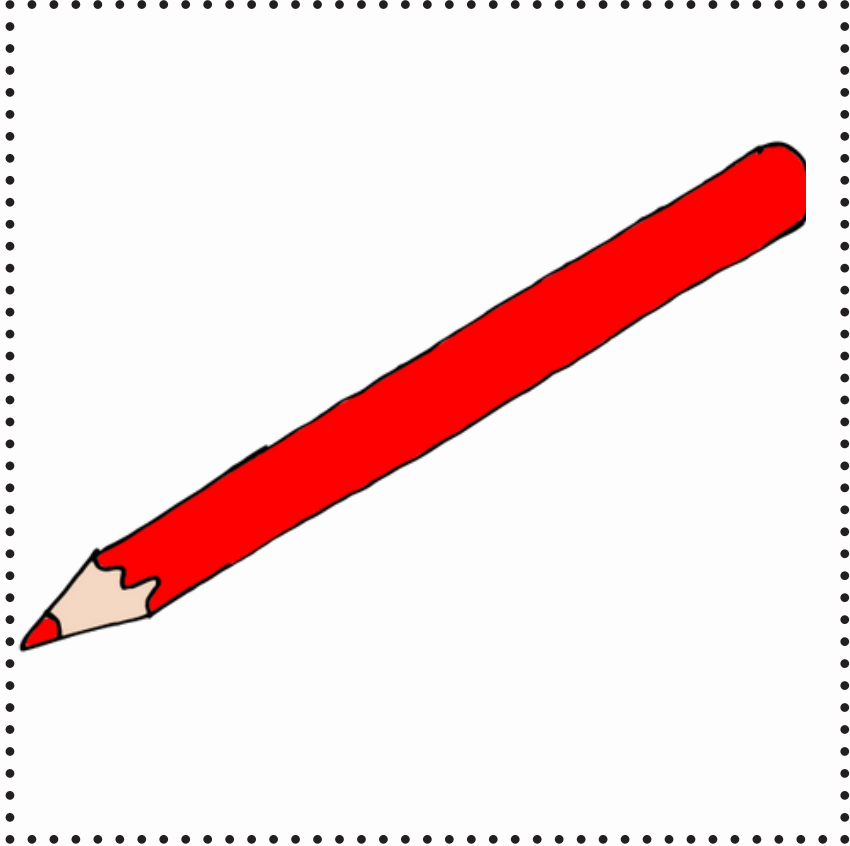
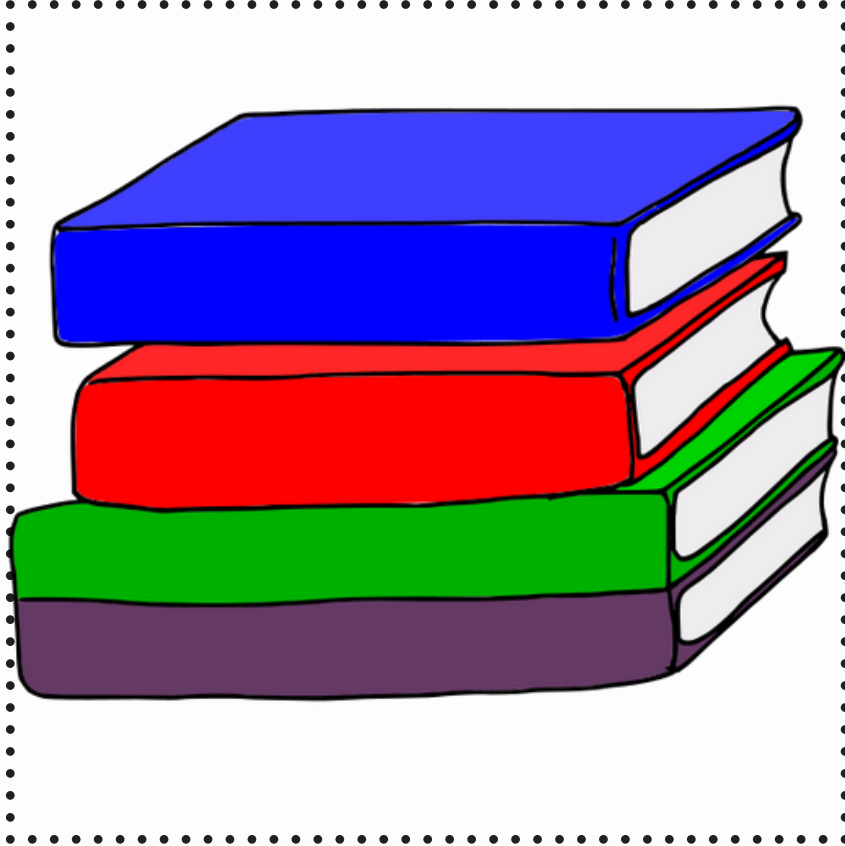

Set 4 Kırtasiye

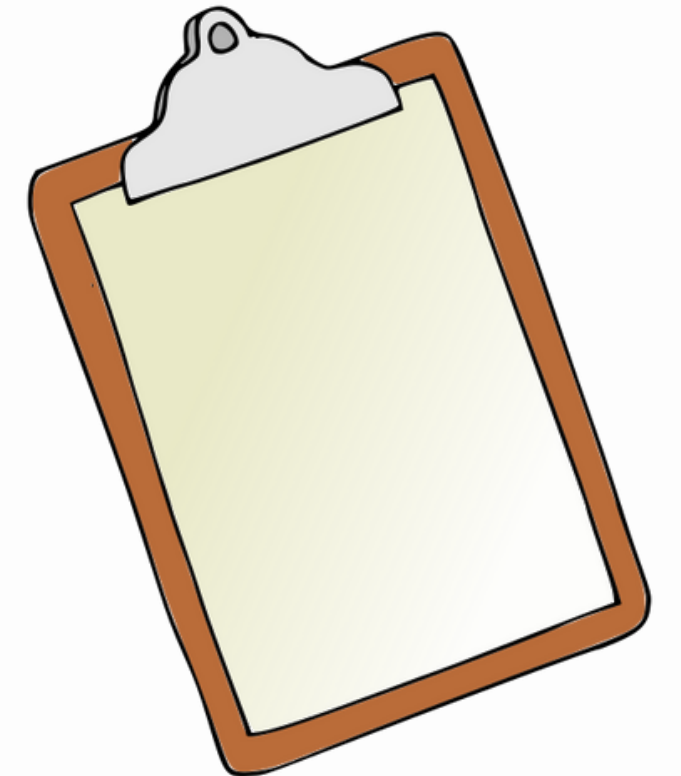
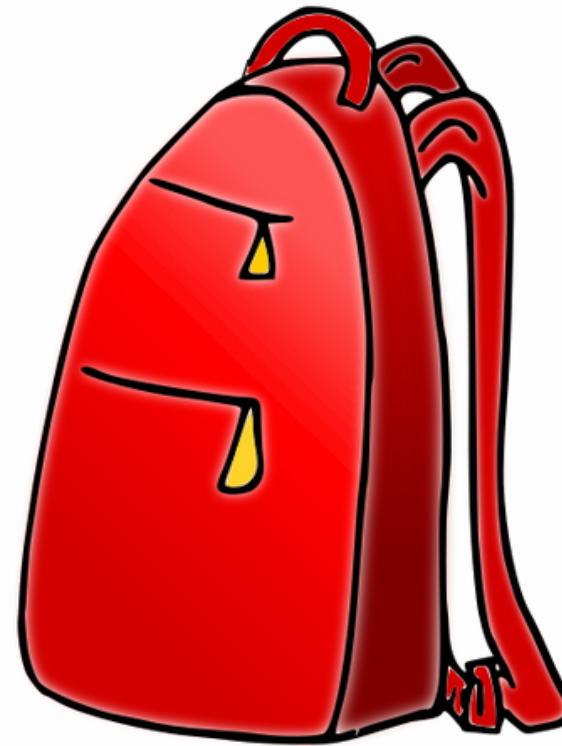
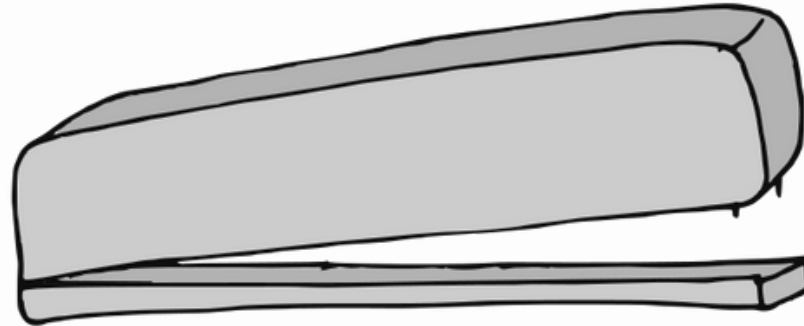
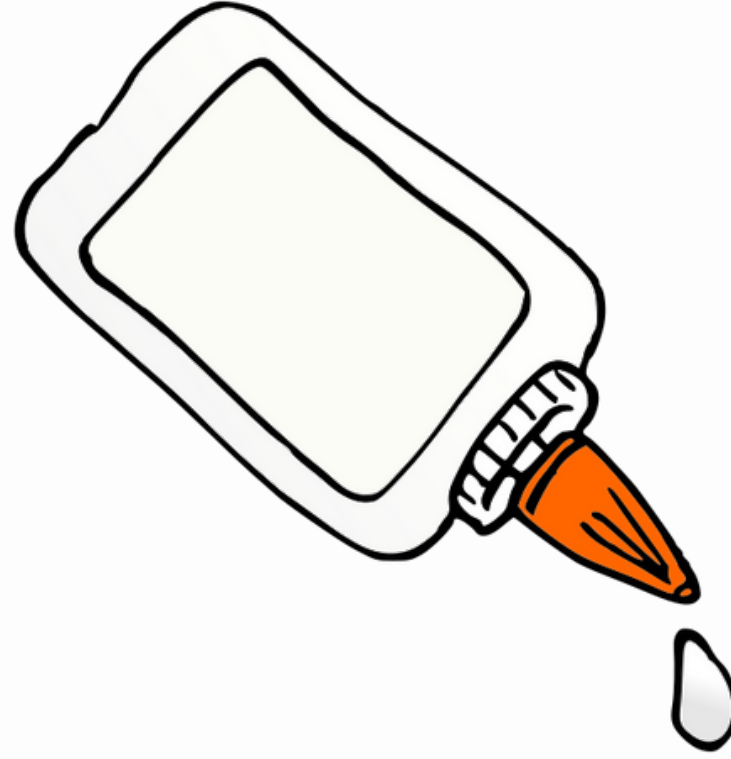
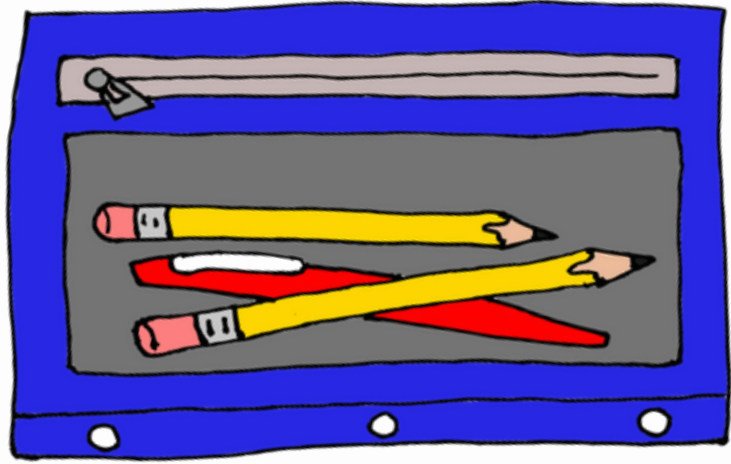

RENKLER

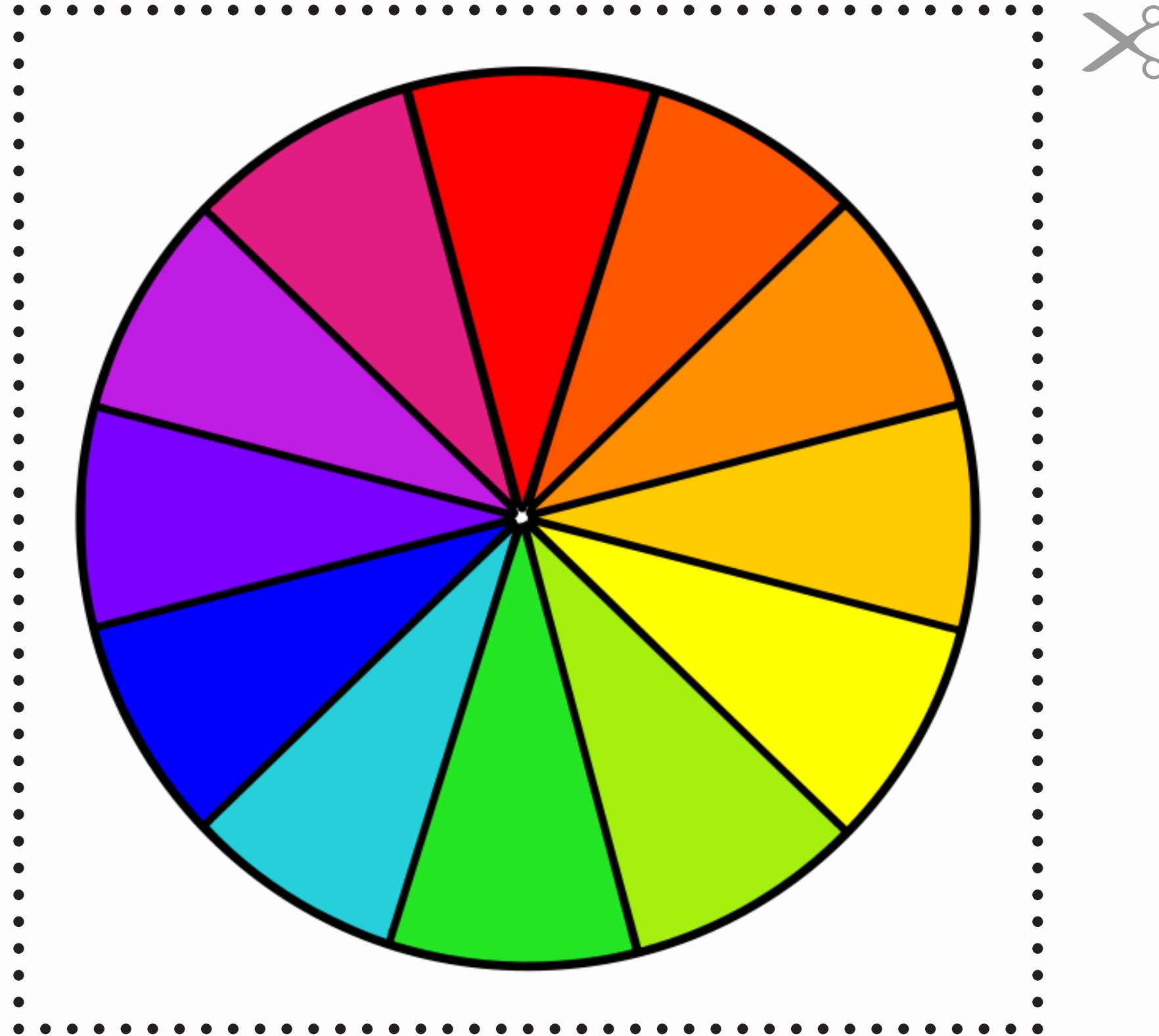

Set 5 Renkler

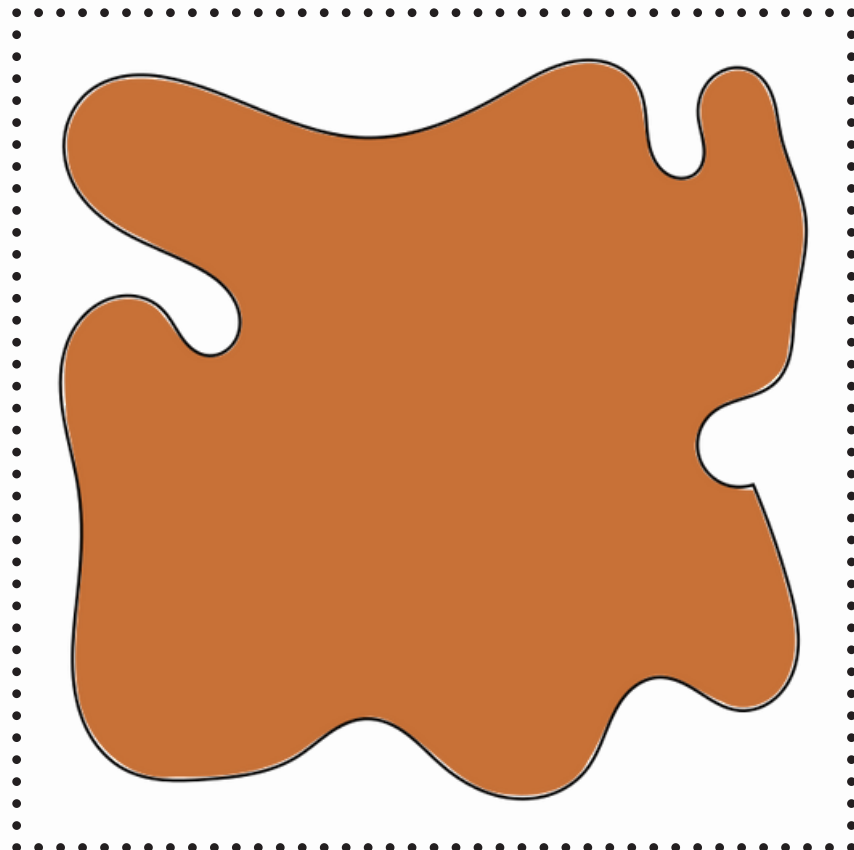
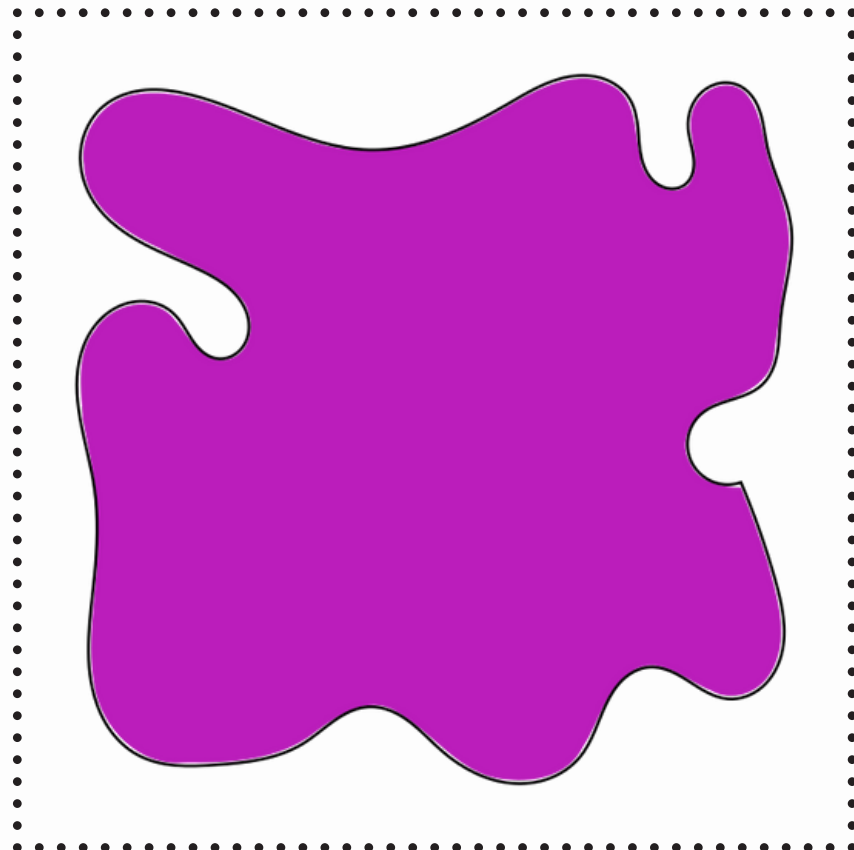
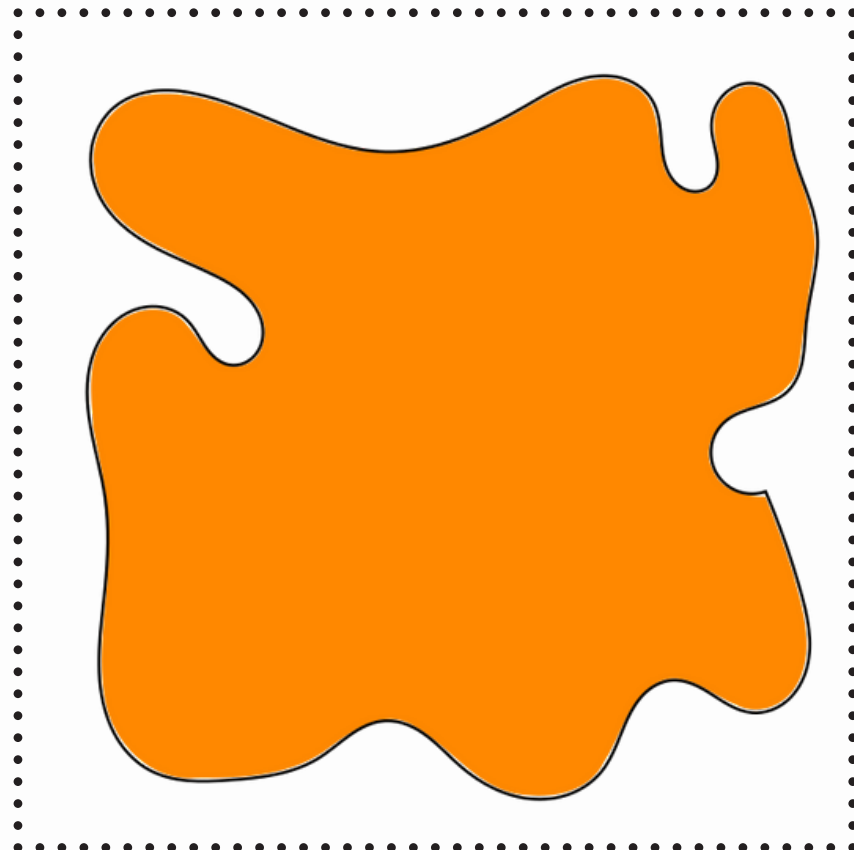
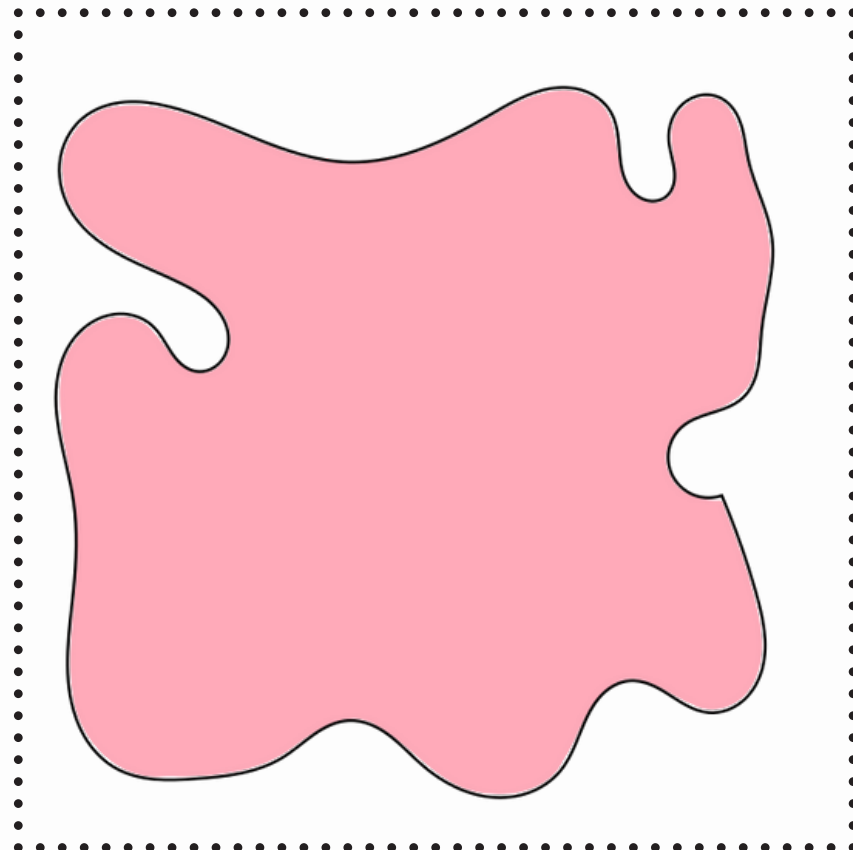
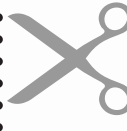
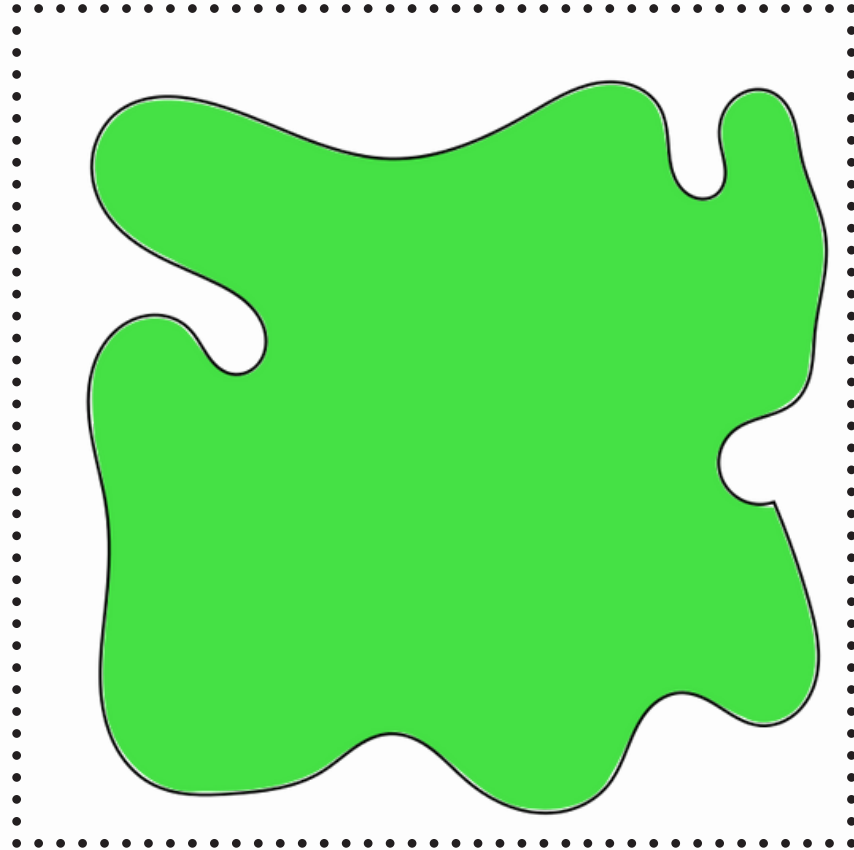
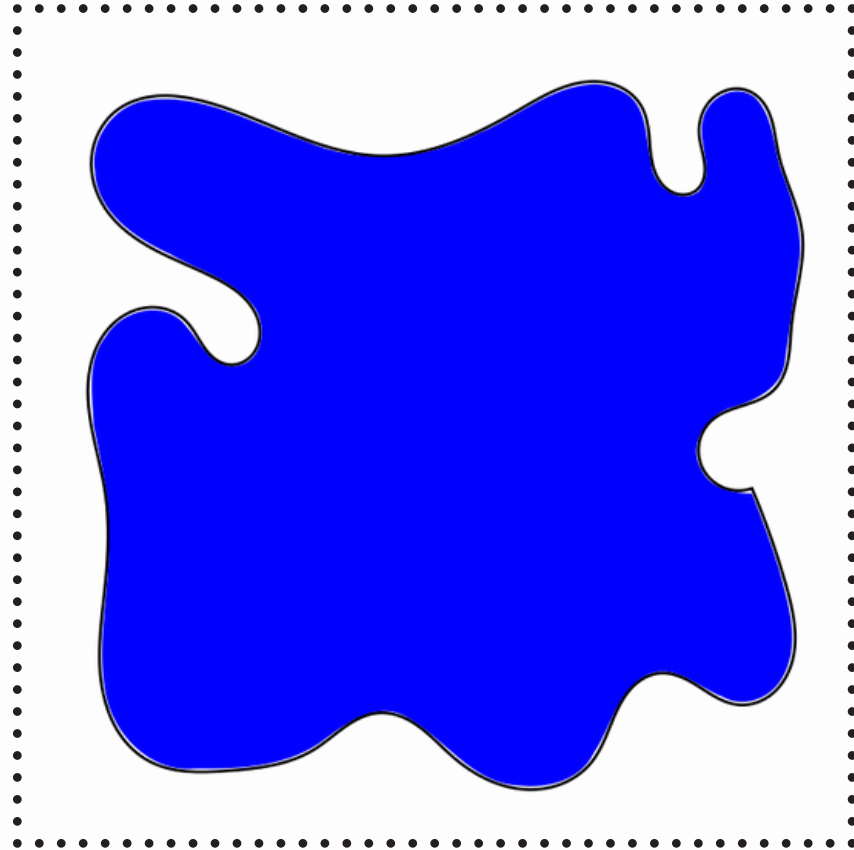
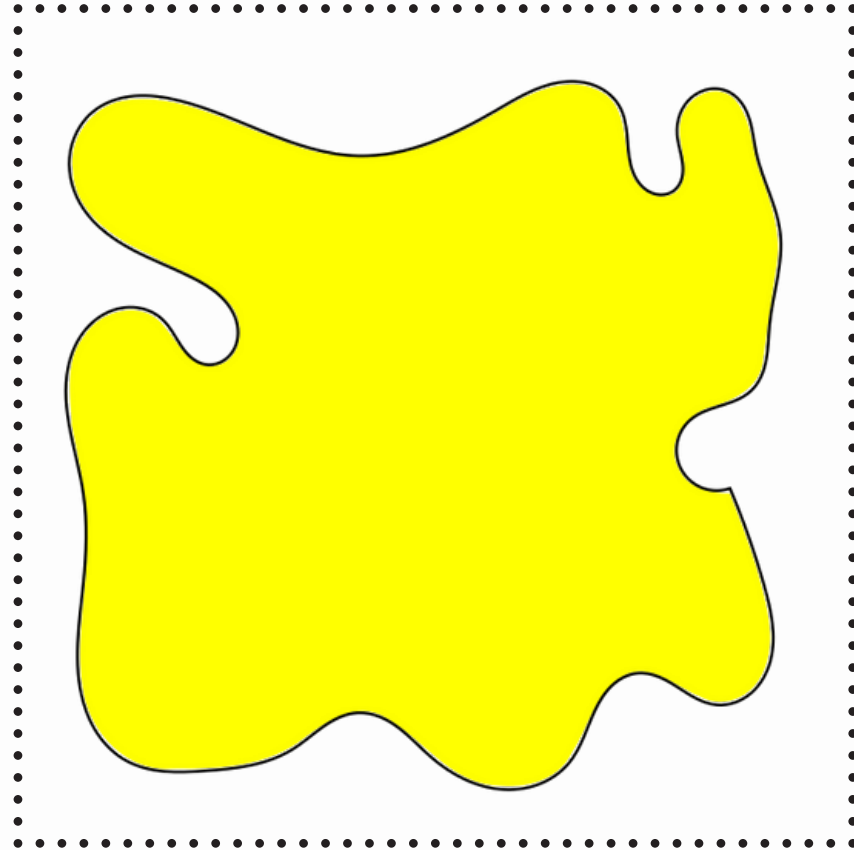
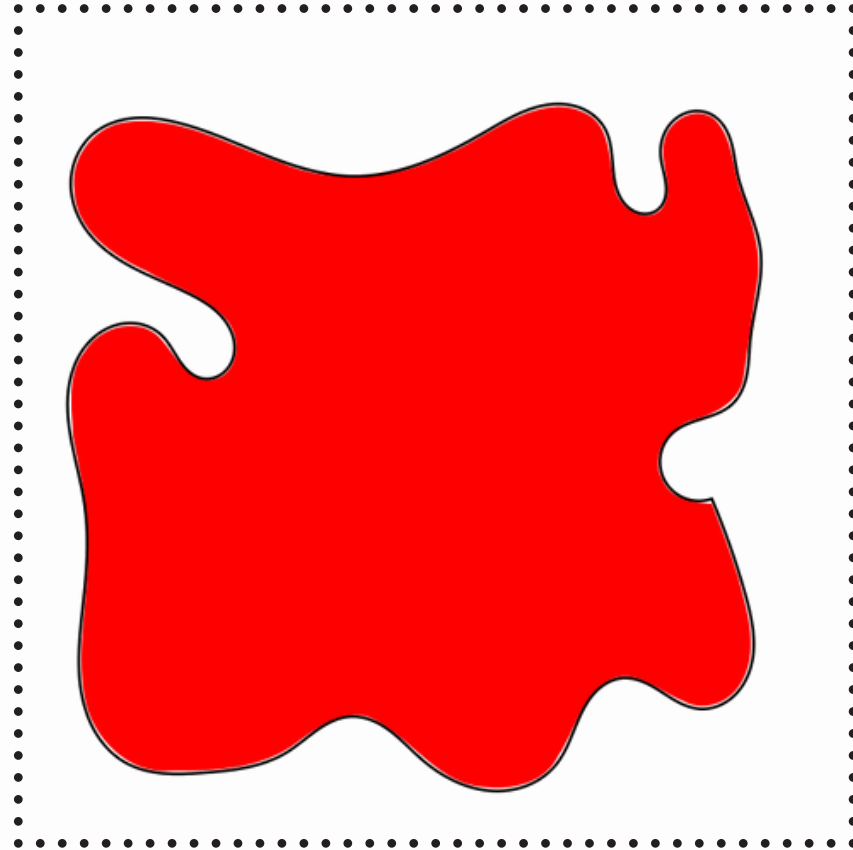

ŞEKİLLER

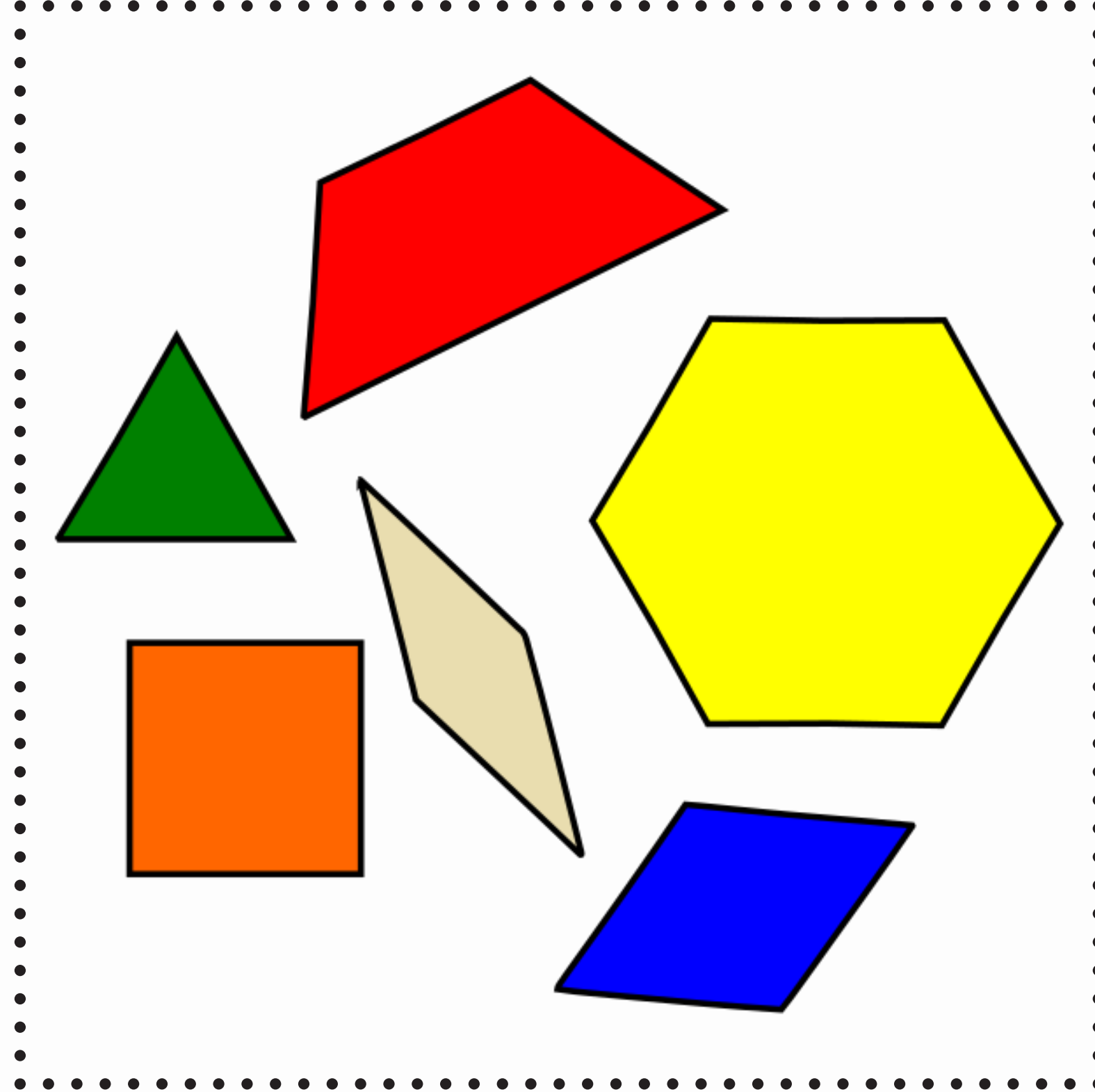

Set 6 Şekiller

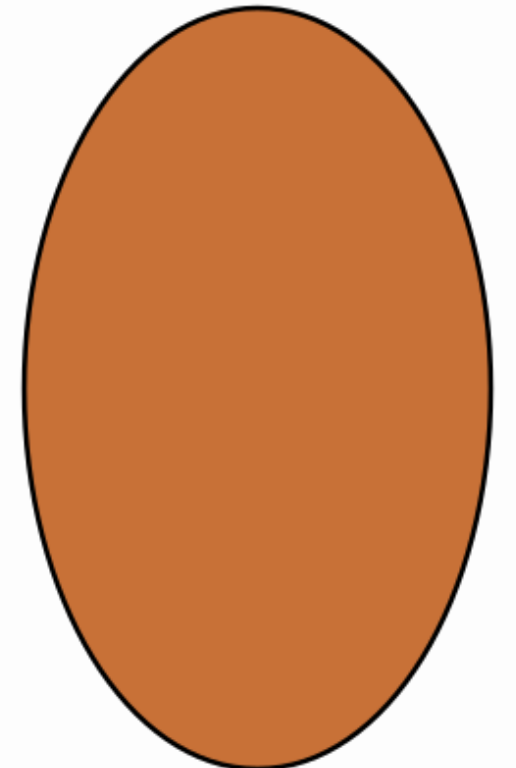
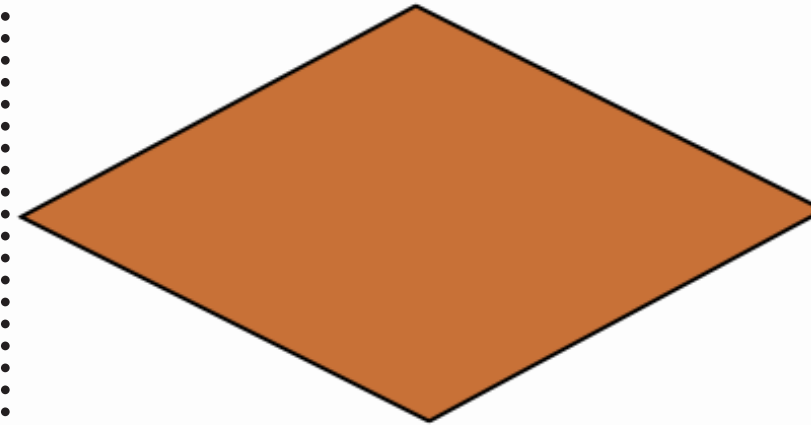
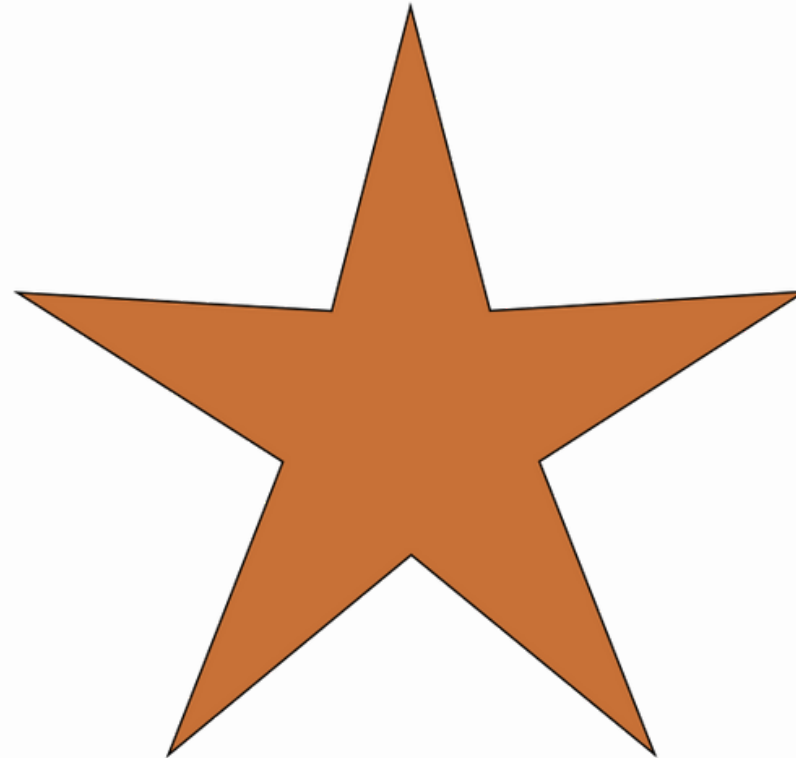
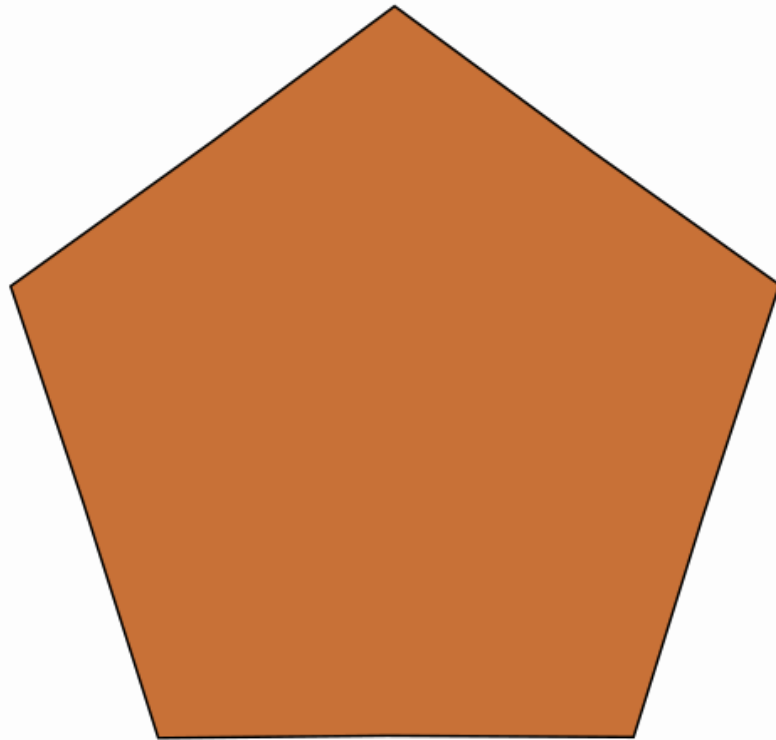
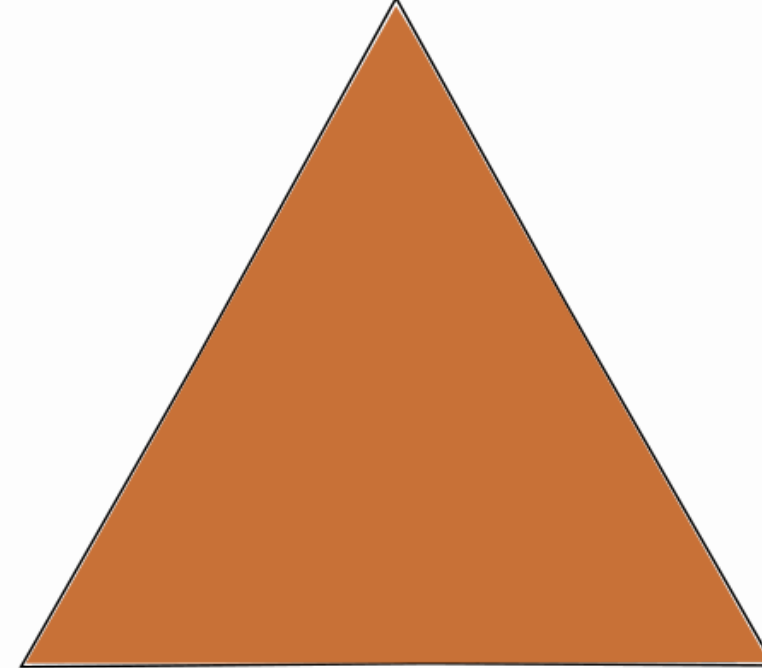
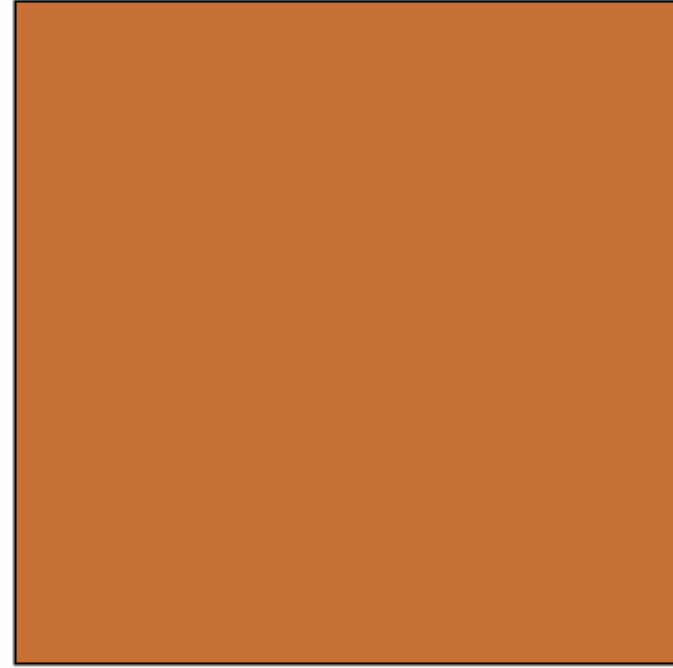
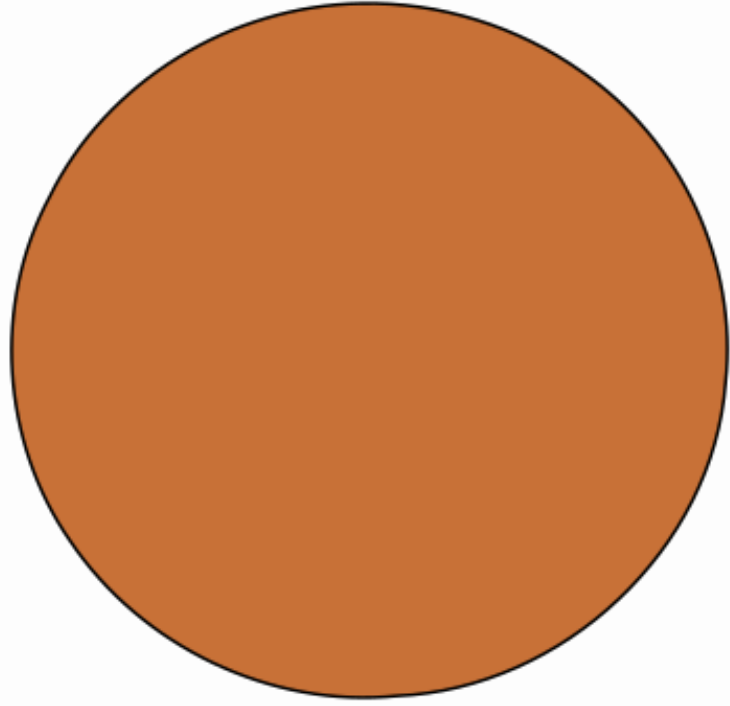

MESLEKLER



Set 7 Meslekler

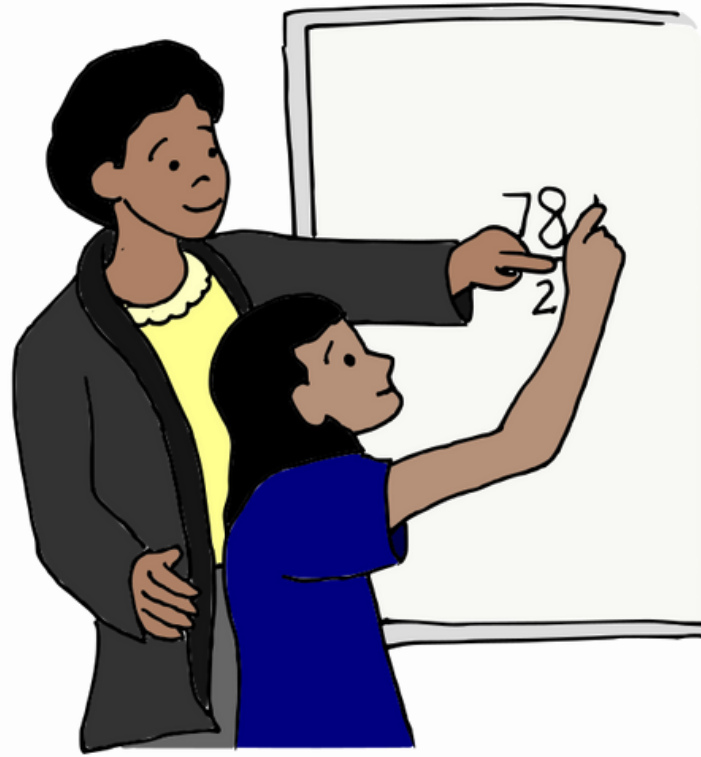



SELÇUKLU OTİZMLİ BİREYLER EĞİTİM VAKFI EĞİTİM MATERYALLERİ SERİSİ

Bu materyal ücretsiz olup eğitim amaçlı kişisel kullanımlar için SOBE VAKFI Eğitim AR-GE Ekibi tarafından oluşturulmuştur. SOBE Vakfı'nın izni olmadan kopyalanması, çoğaltılması ve dağıtılması yasaktır.

Soru ve önerileriniz için aşağıdaki mail adresinden Eğitim AR-GE ekibi ile iletişime geçebilirsiniz.
arge@sobe.org.tr

Örnek eğitim materyallerini indirmek için linki tıklayabilir ya da QR kodunu okutarak indirme işlemini gerçekleştirebilirsiniz.

<https://drive.google.com/drive/u/1/folders/11vgbmlynrWVYdbFaIM-2-yo6Fk9MEYp>



www.sobe.org.tr

